

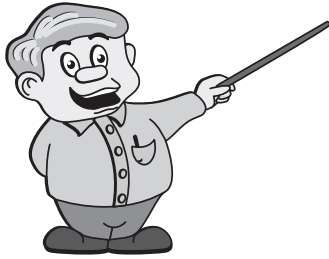

New Parts & Recap of Existing Parts to fit Stryker®

900 SERIES CAST CUTTERS



Did You Know ...

To access the housing for the Stryker 900 series cast cutters, simply remove the screws located under the Power Switch Label and cap.

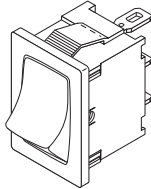
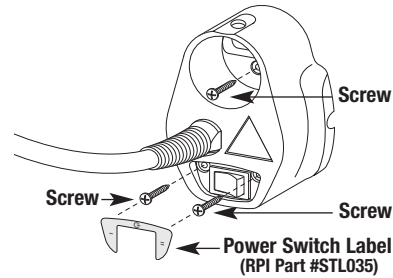

RPI Part #STS034
OEM Part # (No OEM Part # Available)
POWER SWITCH
Models: Cast Cutter: 940 & 941

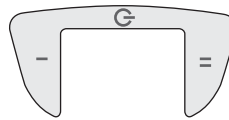

RPI Part #STL035
OEM Part # (No OEM Part # Available)
POWER SWITCH LABEL (3/pkg)
Models: Cast Cutter: 940 & 941

*Perfect for sealing
 Power Switch
 connections!*

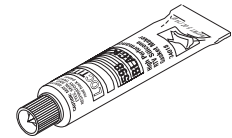

RPI Part #RPS639
OEM Part # (No OEM Part # Available)
SILICONE GASKET MAKER 598
Models: Cast Cutter: 940 & 941



RPI Part #STB031
OEM Part # (No OEM Part # Available)
FRONT BEARING
Models: Cast Cutter: 940 & 941

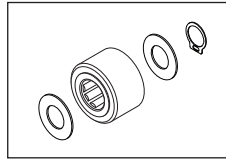

RPI Part #STK030
**OEM Part #28-111 (Retaining Ring only),
 11-275 (Washers only), 81-118 (Needle
 Bearing only)**
ROLLER BEARING KIT
Models: Cast Cutter: 940 & 941



RPI Part #STB032
OEM Part # (No OEM Part # Available)
REAR BEARING
Models: Cast Cutter: 940 & 941



RPI Part #STA028
OEM Part # (No OEM Part # Available)
ARMATURE ASSEMBLY (115VAC)
Models: Cast Cutter: 940

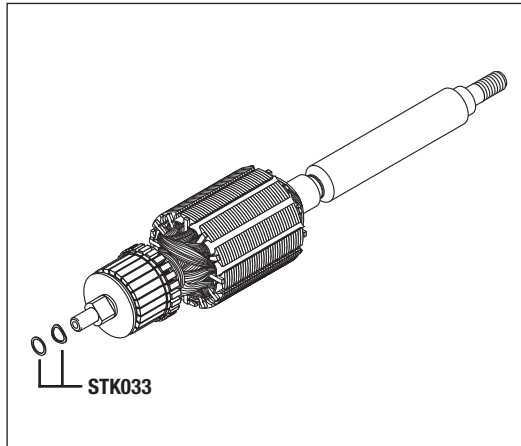

RPI Part #STK033
OEM Part # (No OEM Part # Available)
ARMATURE WASHER KIT
Models: Cast Cutter: 940 & 941

Also fits 800 Series!

RPI Part #STB002
**OEM Part #870-1-13, 940-1-113
 (Brush only), 38-49 (Spring only)**
BRUSH (2/pkg)
Models: Cast Cutter: 940 & 941

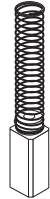

RPI Part #RPC667
OEM Part #58-18
BRUSH CAP (6/pkg)
Models: Cast Cutter: 940 & 941

Look inside for more parts to fit Stryker 800 & 900 Series Autopsy Saws and Cast Cutters!



replacement parts industries, inc.

CALL (800) 221-9723 • FAX (818) 882-7028 • EMAIL order@rpiparts.com • WEBSITE www.rpiparts.com

The above parts are manufactured by Replacement Parts Industries, Inc. to fit Stryker equipment. All product names used in this document are trademarks or registered trademarks of their respective holders. Website 06/08

900 SERIES CAST CUTTERS (Continued)



Now can be used with
800 & 900 Series!

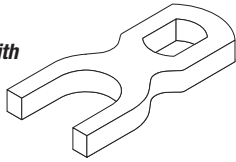

RPI Part #STL016
OEM Part # (No OEM Part # Available)
SHAFT LINK
Models: Cast Cutter: 940 & 941



Now can be used with
800 & 900 Series!

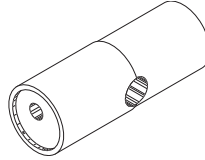

RPI Part #STT010
OEM Part # (No OEM Part # Available)
CAM TOOL
• Used to install and remove Cam
(RPI Part #STC029 & STC009)
Models: Cast Cutter: 940 & 941

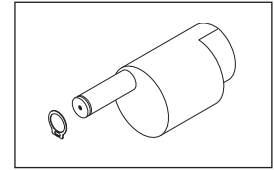

RPI Part #STC029
OEM Part # (No OEM Part # Available)
CAM
Models: Cast Cutter: 940 & 941



RPI Part #STK037
OEM Part # (No OEM Part # Available)
POWER CABLE KIT
• Includes all parts as shown
Models: Cast Cutter: 940 & 941

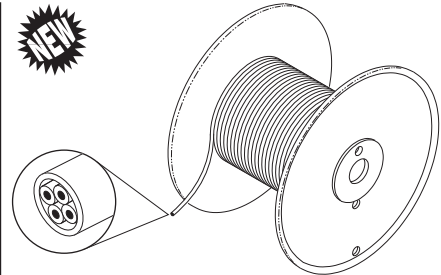
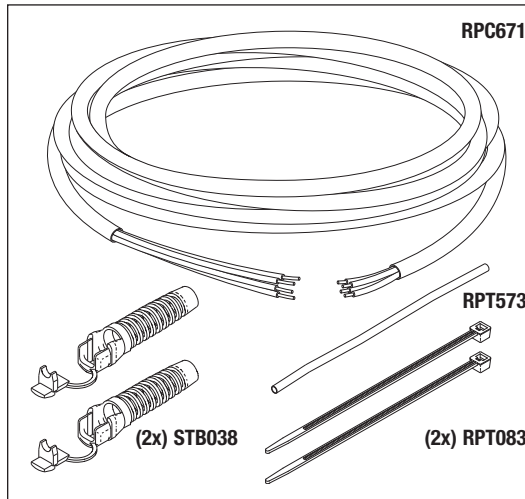

• White PVC Jacket
• Colors: black, red,
green, and yellow

RPI Part #RPC671
OEM Part # (No OEM Part # Available)
CABLE (4 CONDUCTOR)
• Sold by the foot (reel not included)
Models: Cast Cutter: 940 & 941

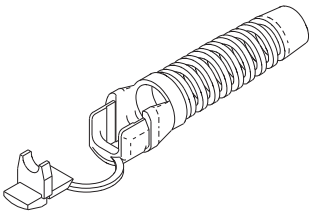

RPI Part #STB038
OEM Part # (No OEM Part # Available)
STRAIN RELIEF BUSHING (5/pkg)
Models: Cast Cutter: 940 & 941

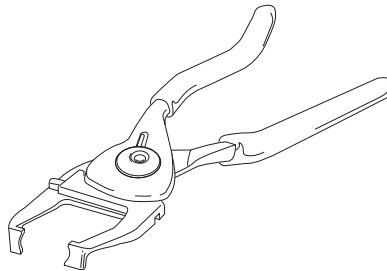

RPI Part #RPT172
OEM Part # (No OEM Part # Available)
STRAIN RELIEF BUSHING PLIERS
Models: Cast Cutter: 940 & 941

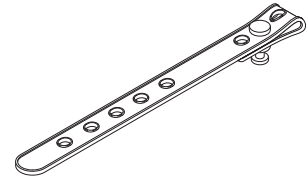

Service Tip
Perfect for strapping the Power Cord
to the Vacuum Hose!

RPI Part #RPS672
OEM Part # (No OEM Part # Available)
CORD STRAP (WHITE 6") (3/pkg)
Models: Cast Cutter: 940 & 941

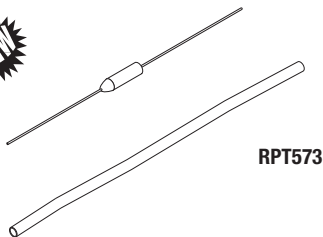

RPI Part #STF036
OEM Part # (No OEM Part # Available)
THERMAL FUSE (104°C)
Models: Cast Cutter: 940 & 941

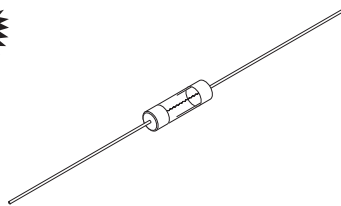

RPI Part #RPF665
OEM Part # (No OEM Part # Available)
AXIAL LEAD FUSE (2-1/2A) (5/pkg)
Models: Cast Cutter: 940

**O-Ring shapes
to fit Housing**

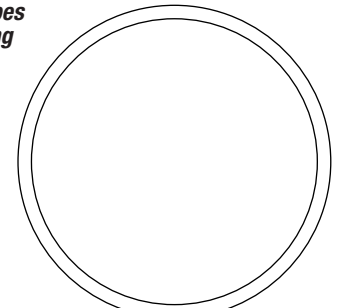

RPI Part #RPO335
OEM Part #45-29
O-RING (12/pkg)
Models: Cast Cutter: 940 & 941

ACTUAL SIZE
1.489" ID x 1.629" OD x .070" C/S

800 SERIES AUTOPSY SAWS AND CAST CUTTERS



Now can be used with
800 & 900 Series!

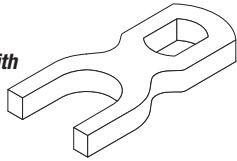

RPI Part #STL016
OEM Part #840-1-5 (800 Series only)

SHAFT LINK

Models: Autopsy Saw: 810 & 811;
Cast Cutter: 840, 841, 848 & 851



Now can be used with
800 & 900 Series!

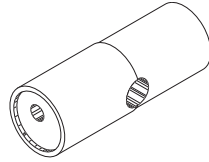

RPI Part #STT010
OEM Part # (No OEM Part # Available)

CAM TOOL

• Used to install and remove Cam
(RPI Part #STC009 & STC029)
Models: Autopsy Saw: 810 & 811;
Cast Cutter: 840, 841, 848 & 851

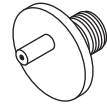

RPI Part #STC009
OEM Part #840-2-7

CAM

Models: Autopsy Saw: 810 & 811;
Cast Cutter: 840, 841, 848 & 851

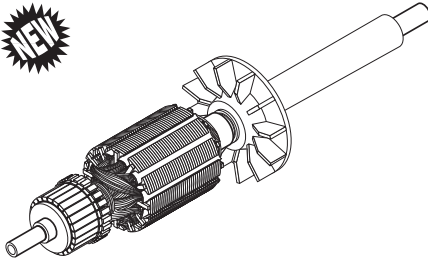

RPI Part #STA026
OEM Part #870-1-8

ARMATURE ASSEMBLY (115VAC)

Models: Autopsy Saw: 810;
Cast Cutter: 840 & 848

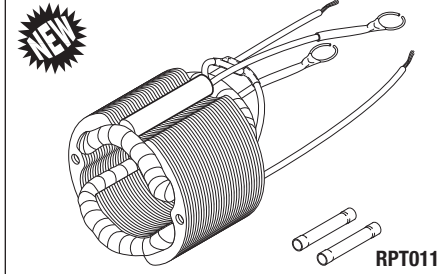

RPI Part #STF027
OEM Part #840-3-32

FIELD ASSEMBLY (115VAC)

Models: Autopsy Saw: 810;
Cast Cutter: 840 & 848

Also fits 900 Series!

RPI Part #STB002
OEM Part #870-1-13, 940-1-113
(Brush only), 38-49 (Spring only)

BRUSH (2/pkg)

Models: Autopsy Saw: 810 & 811;
Cast Cutter: 840, 841, 848 & 851

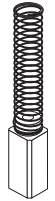

RPI Part #RPC039
OEM Part # (No OEM Part # Available)

BRUSH CAP (6/pkg)

Models: Autopsy Saw: 810 & 811;
Cast Cutter: 840, 841, 848 & 851

RPI Part #STS023
OEM Part #870-1-3

SHAFT

Models: Cast Cutter: 840, 841, 848
& 851

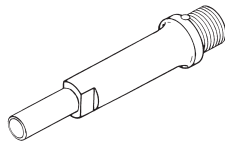

RPI Part #STS018
OEM Part #840-3-21

SWITCH ASSEMBLY

Models: Autopsy Saw: 810 & 811;
Cast Cutter: 840, 841, 848 & 851

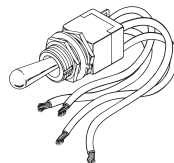

RPI Part #STB015
OEM Part #840-25-11

CAST CUTTER BLADE (2-1/2")

Models: Cast Cutter: 840, 841,
848 & 851

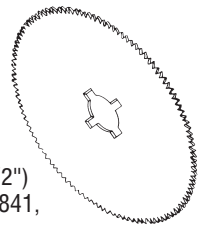

RPI Part #STW025
OEM Part #13-4

INTERNAL TOOTH WASHER

Models: Autopsy Saw: 810 & 811;
Cast Cutter: 840, 841, 848 & 851

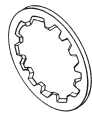

RPI Part #STB003
OEM Part #81-117

FRONT BEARING

Models: Autopsy Saw: 810 & 811;
Cast Cutter: 840, 841, 848 & 851

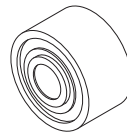

RPI Part #STG013
OEM Part #840-1-10

GASKET

Models: Autopsy Saw: 810 & 811;
Cast Cutter: 840, 841, 848 & 851

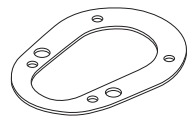

RPI Part #STN017
OEM Part #840-1-14

SHAFT NUT

Models: Autopsy Saw: 810 & 811;
Cast Cutter: 840, 841, 848 & 851

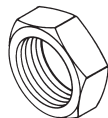

RPI Part #STB004
OEM Part #81-147

NEEDLE BEARING

Models: Autopsy Saw: 810 & 811;
Cast Cutter: 840, 841, 848 & 851

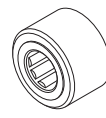

RPI Part #STC011
OEM Part #840-1-13

COLLAR

Models: Autopsy Saw: 810 & 811;
Cast Cutter: 840, 841, 848 & 851



RPI Part #STS021
OEM Part #47-5

OIL SEAL

Models: Autopsy Saw: 810 & 811;
Cast Cutter: 840, 841, 848 & 851



RPI Part #STB005
OEM Part #81-138

REAR BEARING

Models: Autopsy Saw: 810 & 811;
Cast Cutter: 840, 841, 848 & 851



RPI Part #STD012
OEM Part #840-2-4

FELT OIL DISTRIBUTOR

Models: Autopsy Saw: 810 & 811;
Cast Cutter: 840, 841, 848 & 851

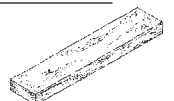



replacement parts industries, inc.

CALL (800) 221-9723 • FAX (818) 882-7028 • EMAIL order@riparts.com • WEBSITE www.riparts.com

LIST OF RPI PARTS TO FIT STRYKER
AUTOPSY SAWS AND CAST CUTTERS
AS OF DECEMBER, 2008.

| RPI PART # | OEM PART # | DESCRIPTION | AUTOPSY SAWS & CAST CUTTERS 800 & 900 SERIES | | | | | | | | NOTES |
|------------|--|----------------------------------|--|-----|-----|-----|-----|-----|-----|-----|-------|
| | | | 810 | 811 | 840 | 841 | 848 | 851 | 940 | 941 | |
| RPC039 | (No OEM Part # Available) | BRUSH CAP WITH - 6/PKG | 810 | 811 | 840 | 841 | 848 | 851 | | | |
| RPC667 | 58-18 | BRUSH CAP - 6/PKG | | | | | | | 940 | 941 | |
| RPC671 | (No OEM Part # Available) | CABLE (4 CONDUCTOR) | | | | | | | 940 | 941 | |
| RPF665 | (No OEM Part # Available) | AXIAL LEAD FUSE (2-1/2A) - 5/PKG | | | | | | | 940 | 941 | |
| RPO335 | 45-29 | O-RING - 12/PKG | | | | | | | 940 | 941 | |
| RPS639 | (No OEM Part # Available) | SILICONE GASKET MAKER 598 | | | | | | | 940 | 941 | |
| RPS672 | (No OEM Part # Available) | CORD STRAP (WHITE-6") - 3/PKG | | | | | | | 940 | 941 | |
| RPT172 | (No OEM Part # Available) | STRAIN RELIEF BUSHING PLIERS | | | | | | | 940 | 941 | |
| STA026 | 870-1-8 | ARMATURE ASSEMBLY (115VAC) | 810 | | 840 | | 848 | | | | |
| STA028 | (No OEM Part # Available) | ARMATURE ASSEMBLY (115VAC) | | | | | | | 940 | | |
| STB002 | 870-1-13/940-1-113 (Brush Only) 38-49 (Spring Only) | BRUSH - 2/PKG | 810 | 811 | 840 | 841 | 848 | 851 | 940 | 941 | |
| STB003 | 81-117 | FRONT BEARING | 810 | 811 | 840 | 841 | 848 | 851 | | | |
| STB004 | 81-147 | NEEDLE BEARING | 810 | 811 | 840 | 841 | 848 | 851 | | | |
| STB005 | 81-138 | REAR BEARING | 810 | 811 | 840 | 841 | 848 | 851 | | | |
| STB015 | 840-25-11 | CAST CUTTER BLADE (2-1/2") | | | 840 | 841 | 848 | 851 | | | |
| STB031 | (No OEM Part # Available) | FRONT BEARING | | | | | | | 940 | 941 | |
| STB032 | (No OEM Part # Available) | REAR BEARING | | | | | | | 940 | 941 | |
| STB038 | (No OEM Part # Available) | STRAIN RELIEF BUSHING - 5/PKG | | | | | | | 940 | 941 | |
| STC009 | 840-2-7 | CAM | 810 | 811 | 840 | 841 | 848 | 851 | | | |
| STC011 | 840-1-13 | COLLAR | 810 | 811 | 840 | 841 | 848 | 851 | | | |
| STC029 | (No OEM Part # Available) | CAM | | | | | | | 940 | 941 | |
| STD012 | 840-2-4 | FELT OIL DISTRIBUTOR | 810 | 811 | 840 | 841 | 848 | 851 | | | |
| STF027 | 840-3-32 | FIELD ASSEMBLY (115VAC) | 810 | | 840 | | 848 | | | | |
| STF036 | (No OEM Part # Available) | THERMAL FUSE (104°C) | | | | | | | 940 | 941 | |
| STG013 | 840-1-10 | GASKET | 810 | 811 | 840 | 841 | 848 | 851 | | | |
| STK030 | 28-11 (Retaining Ring only)/ 11-275 (Washers only)/ 81-118 (Needle Bearing only) | ROLLER BEARING KIT | | | | | | | 940 | 941 | |
| STK033 | (No OEM Part # Available) | ARMATURE WASHER KIT | | | | | | | 940 | 941 | |
| STK037 | (No OEM Part # Available) | POWER CABLE KIT | | | | | | | 940 | 941 | |
| STL016 | 840-1-5 (810, 811, 840, 851 & 848)/ (No OEM Part # Available for 940 & 941) | SHAFT LINK | 810 | 811 | 840 | 841 | 848 | 851 | 940 | 941 | |
| STL035 | (No OEM Part # Available) | POWER SWITCH LABEL - 3/PKG | | | | | | | 940 | 941 | |
| STN017 | 840-1-14 | SHAFT NUT | 810 | 811 | 840 | 841 | 848 | 851 | | | |
| STS018 | 840-3-21 | SWITCH ASSEMBLY | 810 | 811 | 840 | 841 | 848 | 851 | | | |
| STS021 | 47-5 | OIL SEAL | 810 | 811 | 840 | 841 | 848 | 851 | | | |
| STS023 | 870-1-3 | SHAFT | | | 840 | 841 | 848 | 851 | | | |
| STS034 | (No OEM Part # Available) | POWER SWITCH | | | | | | | 940 | 941 | |
| STT010 | (No OEM Part # Available) | CAM TOOL | 810 | 811 | 840 | 841 | 848 | 851 | 940 | 941 | |
| STW025 | 13-4 | INTERNAL TOOTH WASHER | 810 | 811 | 840 | 841 | 848 | 851 | | | |



replacement parts industries, inc.

20338 Corisco Street • Chatsworth, California • 91311

PRESORTED STANDARD
U.S. POSTAGE PAID
VAN NUYS, CA
PERMIT NO. 2399

ADDRESS SERVICES REQUESTED

**LOOK INSIDE!
NEW PARTS & UPDATE ON EXISTING PARTS
TO FIT STRYKER AUTOPSY SAWS & CAST CUTTERS
800 & 900 SERIES.**