

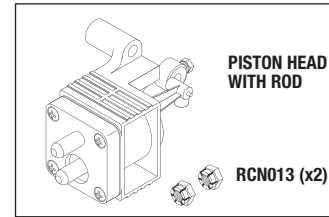

NEW PARTS TO FIT TUTTNAUER "E" SERIES

TUTTNAUER

AIR PUMP (115VAC)
RPI Part #TUP100
OEM Part #02200051
Models: EZ9, EZ10, 2340EA, 2540EA & 3870EA

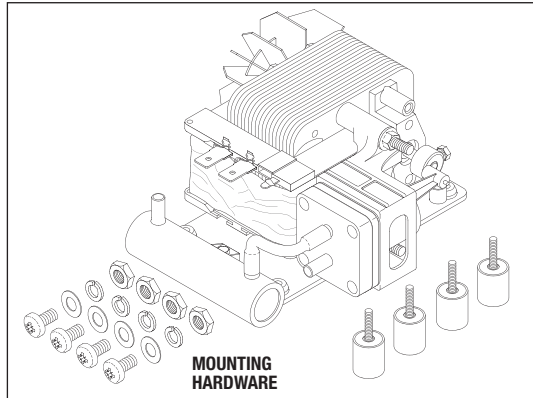

AIR PUMP REPAIR KIT
RPI Part #TUK102
OEM Part # (No OEM Part # Available)
Models: EZ9, EZ10, EZ10k, 2340EA/EKA, 2540EA/EKA & 3870EA

AIR PUMP (230VAC)
RPI Part #TUP101
OEM Part #02200052
Models: EZ10k, 2340EA/EKA, 2540EA/EKA & 3870EA

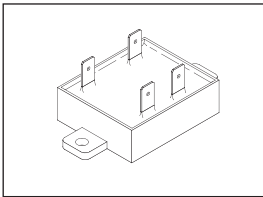

SOLID STATE RELAY (PUMP)
RPI Part #TUR105
OEM Part #04400339
Models: EZ9, EZ10, EZ10k, 2340EA/EK/EKA & 2540EA/EK/EKA

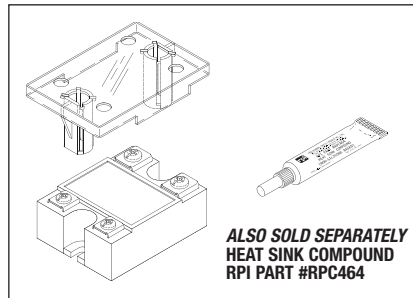

SOLID STATE RELAY (HEATER)
RPI Part #TUR104
OEM Part #04400338
Models: EZ9, EZ10, EZ10k, 1730E, 2340E/EA/EK/EKA & 2540E/EA/EK/EKA

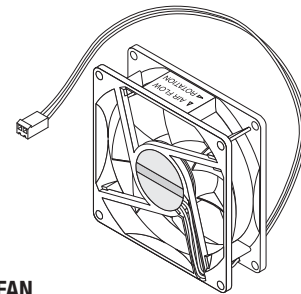

AXIAL FAN
RPI Part #TUF071
OEM Part #04203801
Models: EZ9, EZ10, EZ10k, 1730E/EK, 2340E/EA/EK/EKA & 2540E/EA/EK/EKA

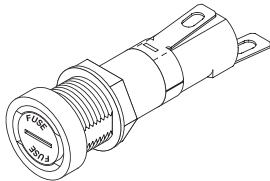

FUSE HOLDER
RPI Part #RPH659
OEM Part #01910103
Models: EZ9, EZ10, EZ10k, 1730E/EK, 2340E/EA/EK/EKA, 2540E/EA/EK/EKA & 3870E/EA

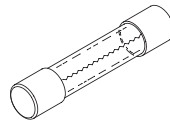

FUSE (2A, 250V) (AIR PUMP)
RPI Part #RPF047
OEM Part #ELE035-0056
Models: EZ9, EZ10, EZ10k, 2340EA, 2540EA & 3870EA

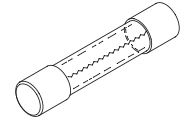

FUSE (1-1/4A, 250V) (AIR PUMP* and WATER PUMP*)
RPI Part #RPF073
OEM Part #ELE035-0055
Models: EZ9, EZ10, EZ10k, 1730E/EK, 2340E/EA/EK/EKA, 2540E/EA/EK/EKA & 3870E/EA
 * Depending on Voltage

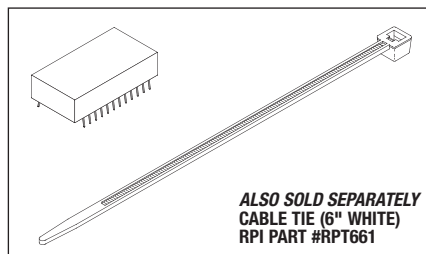

CLOCK CHIP (WITH BATTERY)
RPI Part #TUC107
OEM Part #0180202
Models: EZ9, EZ10, EZ10k, 1730E, 2340E/EA/EK/EKA & 2540E/EA/EK/EKA

FUSE (2A, 250V) (POWER SUPPLY)
RPI Part #RPF367
OEM Part #01910105
Models: EZ9, EZ10, 1730E, 2340E/EA/EK/EKA & 2540E/EA/EKA



replacement parts industries, inc.

CALL (800) 221-9723 • FAX (818) 882-7028 • EMAIL order@riparts.com • WEBSITE www.riparts.com

The above parts are manufactured by Replacement Parts Industries, Inc. to fit Tuttnauer equipment. All product names used in this document are trademarks or registered trademarks of their respective holders. WEB 01/08

Introducing... Trouble-Shooting Guide for the Tuttnauer "M" Series!

The RPI Trouble-Shooting Guide for the "M" Series is a great source for:

- Preventative Maintenance Tips
- Water/Steam System Trouble-Shooting Tips
- Multi-Purpose Valve Assembly Trouble-Shooting Tips
- Electrical Trouble-Shooting Tips and Diagrams
- Detailed Exploded View
- Complete Listing of RPI Parts to fit Tuttnauer "M" Series

Download the new guide from RPI's website today!
www.rpiparts.com

Click [RPI Tech Help](#). Select [Trouble-Shooting Guides and Exploded Views](#).

