



Introducing New Parts to fit AMSCO/STERIS Century V116 and V120 Sterilizers!

AMSCO/STERIS

RPI Part #AMP214
OEM Part #764326-646

PM PACK (MISCELLANEOUS)

- Includes:
 - (1) Check Valve (1/4") (RPI Part #AMV228);
 - (1) Filter Element (RPI Part #AME200);
 - (2) Steam Trap Assembly Repair Kit (RPI Part #AMK188);
 - (3) Check Valve (1/2") (RPI Part #AMV229);
 - (1 pkg of 5) Fuse (5A, 250V) - Time Delay (RPI Part #RPF067); and,
 - (1 pkg of 5) Fuse (4A, 250V) - Fast Acting (RPI Part #RPF050)
- All parts also sold separately

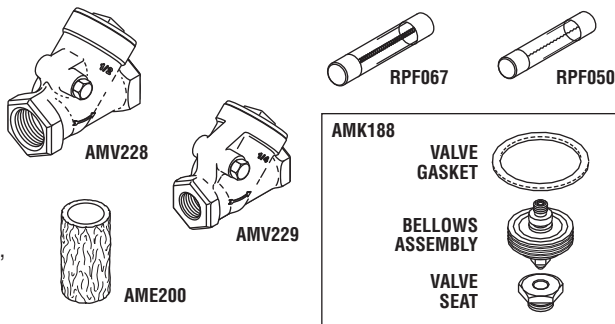

RPI Part #AMV228
OEM Part #10278-091

CHECK VALVE (1/4")

- **CK14**
 - Also Available: Check Valve Rebuild Kit (RPI Part #AMK230)
 - Also included in PM Pack (Misc) (RPI Part #AMP214)
- Note:** CK14 is plumbed in line with Exhaust Manifold

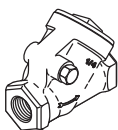

RPI Part #AMK230
OEM Part #10278-091
(Complete Check Valve)

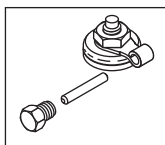

CHECK VALVE REBUILD KIT (1/4")

- PTFE Seat Disk (White)
 - Kit includes all parts as shown
- Fits:** Check Valve (1/4") / CK14

RPI Part #AMV229
OEM Part #150822-354

CHECK VALVE (1/2")

- **CK1, CK2 & CK3**
 - Also Available: Check Valve Rebuild Kit (RPI Part #AMK231)
 - Also included in PM Pack (Misc) (RPI Part #AMP214)
- Note:** CK1 & CK2 are plumbed between Water Ejector and Waste Funnel; and, CK3 is plumbed between TR-2 Steam Trap and CK14 Check Valve

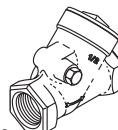

RPI Part #AMK231
OEM Part #150822-354
(Complete Check Valve)

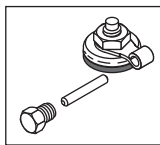

CHECK VALVE REBUILD KIT (1/2")

- Buna-N Seat Disk (Black)
 - Kit includes all parts as shown
- Fits:** Check Valve (1/2") / CK1, CK2 & CK3

RPI Part #AME200
OEM Part #129360-802

FILTER ELEMENT

- 1.40" OD x 2.50" LG
 - Also included in PM Pack (Misc) (RPI Part #AMP214)
- Fits:** Air Filter Housing



RPI Part #AMV206
OEM Part #93918-066

BALL VALVE (3/4")

- "Water Supply" handle
- Fits:** Mounted below chamber door

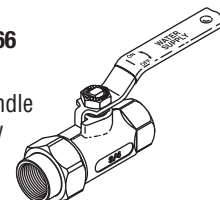

RPI Part #AMV205
OEM Part #93918-212

BALL VALVE (1/4")

- "Emergency Exhaust" handle
- Fits:** Mounted above chamber door

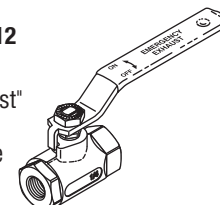

RPI Part #AMS202
OEM Part #150828-459

STRAINER (1/2")

- Includes: Strainer Element (1/2") (RPI Part #AMK232)
- Fits:** Plumbed in line with TR-2 Steam Trap

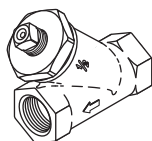

RPI Part #AMK232
OEM Part #150828-459
(Complete 1/2" Strainer)



STRAINER ELEMENT (1/2")

- .62" OD x 1.64" Long
 - 80 Mesh S.S. screen with PTFE O-ring
 - Also Available: Strainer (1/2") (RPI Part #AMS202)
- Fits:** Strainer (1/2")

RPI Part #AMS203
OEM Part #47708-091

STRAINER (3/4")

- Includes: Strainer Element (3/4") (RPI Part #AME233)
 - Also Available: Strainer Element (3/4") (RPI Part #AME233)
- Fits:** Plumbed in line between Water Manifold and M1 Ball Valve

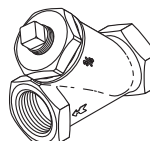

RPI Part #AME233
OEM Part #47708-091
(Complete 3/4" Strainer)



STRAINER ELEMENT (3/4")

- .88" OD x 1.76" Long
 - 24 Mesh S.S. screen
 - Also Available: Strainer (3/4") (RPI Part #AMS203)
- Fits:** Strainer (3/4")

RPI Part #AMV201
OEM Part #93918-013

SAFETY VALVE (50 PSI)

- 1/2 MPT Inlet x 3/4 FPT Outlet
 - Cracking Pressure: 50 PSI
- Fits:** Chamber assembly

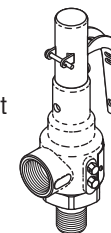

RPI Part #AMX218
OEM Part #136809-844

HEAT EXCHANGER

- 12.20" x 4.37" x 2.05"
- Rated for up to 450 PSI and 437° F Steam

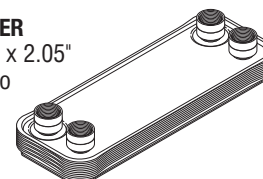

replacement parts industries, inc.

CALL (800) 221-9723 • FAX (818) 882-7028 • EMAIL order@rpiparts.com • WEBSITE www.rpiparts.com

The above parts are manufactured by Replacement Parts Industries, Inc. to fit AMSCO/Steris equipment. All product names used in this document are trademarks or registered trademarks of their respective holders. Web 08/10

Bulk Sterilizers and Sterilizer Washers

Models: Century V116 and V120 (continued)

RPI Part #AMK111
OEM Part
#P754359-001

3/8" PRV KIT

- Includes all parts as shown
 - All parts also sold separately - see Chart below
- Fits:** PM for PR1

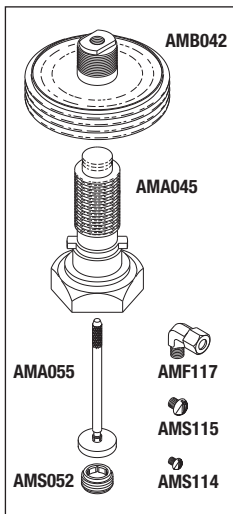

RPI Part #AMT187
OEM Part #P129222-001

STEAM TRAP ASSEMBLY (1/2" VALVE)

- Includes all parts as shown
 - Also available:
- Steam Trap Assembly Repair Kit (RPI Part #AMK188)
- Fits:** Jacket drain assembly

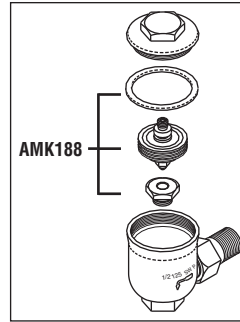

RPI Part #AMK188
OEM Part #P764080-001/764080-091

STEAM TRAP ASSEMBLY REPAIR KIT

- Includes all parts as shown
 - Also available: Steam Trap Assembly (RPI Part #AMT187)
 - Also included in PM Pack (Misc) (RPI Part #AMP214)
- Fits:** Steam trap valve and Exhaust manifold

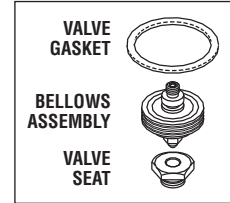

RPI Part #CSK050
OEM Part #P764326-621

SOLENOID VALVE REPAIR KIT

- Includes all parts as shown
 - Diaphragm style repair kit
- Fits:** S-4 Water Supply & S-7 Manifold

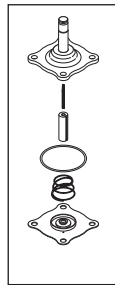

RPI Part #AMK183
OEM Part #P764187-001 (S26) & 764326-482 (S3)

SOLENOID VALVE REPAIR KIT

- Includes all parts as shown
 - Diaphragm style repair kit
- Fits:** Exhaust manifold

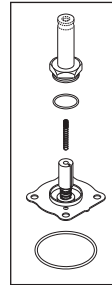

RPI Part #RPF050
OEM Part #764317-825

FUSE (4A, 250V) - FAST ACTING (5/pkg)
Fits: Power Supply F1 and F2 Fuse

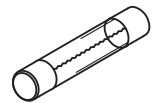

RPI Part #RPF067
OEM Part #764317-463

FUSE (5A, 250V) - TIME DELAY (5/pkg)
Fits: Control Box F3 Fuse

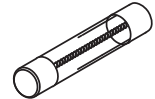

RPI Part #RPT113
MAX REGISTER THERMOMETER

- Accuracy Rating: ± 1 Division ($\pm 2^\circ\text{F}$)
- Range: 150°F to 350°F



RPI PART #	OEM PART #	DESCRIPTION	NOTES
AMA045	P026836-091	3/8" BONNET & SYLPHON	
AMA055	P028267-091	3/8" VALVE STEM ASSEMBLY	
AMB042	P035880-091	BELLOWS	
AME200	129360-802	FILTER ELEMENT	
AME233	47708-091 (Complete 3/4" Strainer)	STRAINER ELEMENT (3/4")	
AMF117	P006750-044	90 DEGREE ELBOW ADAPTOR	
AMK111	P754359-001	3/8" PRV KIT	
AMK183	764326-482 (S3) & P764187-001 (S26)	SOLENOID VALVE REPAIR KIT	
AMK188	P764080-001 / 764080-091	STEAM TRAP ASSEMBLY REPAIR KIT	
AMK230	10278-091 (Complete Check Valve)	CK VLV REBUILD KIT (1/4")	
AMK231	150822-354 (Complete Check Valve)	CK VLV REBUILD KIT (1/2")	
AMK232	150828-459 (Complete 1/2" Strainer)	STRAINER ELEMENT (1/2")	
AMP214	764326-646	PM PACK (MISCELLANEOUS)	
AMS052	P005685-061	3/8" VALVE SEAT	
AMS114	P009276-041	SLOTTED ROUND HEAD SCREW (25/PKG)	
AMS115	P003969-041	SLOTTED ROUND HEAD SCREW (25/PKG)	
AMS202	150828-459	STRAINER (1/2")	
AMS203	47708-091	STRAINER (3/4")	
AMT187	P129222-001	STEAM TRAP ASSEMBLY	
AMV201	93918-013	SAFETY VALVE (50 PSI)	
AMV205	93918-212	BALL VALVE (1/4")	
AMV206	93918-066	BALL VALVE (3/4")	
AMV228	10278-091	CHECK VALVE (1/4")	
AMV229	150822-354	CHECK VALVE (1/2")	
AMX218	136809-844	HEAT EXCHANGER	
CSK050	P764326-621	SOLENOID VALVE REPAIR KIT	
RPF050	764317-825	FUSE (4A, 250V) - FAST ACTING (5/PKG)	
RPF067	764317-463	FUSE (5A, 250V) - TIME DELAY (5/PKG)	
RPT113	No OEM Part # Available	MAX REGISTER THERMOMETER	



replacement parts industries, inc.

CALL (800) 221-9723 • FAX (818) 882-7028 • EMAIL order@rpiparts.com • WEBSITE www.rpiparts.com

The above parts are manufactured by Replacement Parts Industries, Inc. to fit AMSCO/Steris equipment. All product names used in this document are trademarks or registered trademarks of their respective holders. Web 08/10